

For Services and Support



TEL

86-755-21612590
1-833-629-4832 (North America)
34-930-038094(Europe)



EMAIL

SUPPORT@TOPDON.COM



WEBSITE

WWW.TOPDON.COM



FACEBOOK

@TOPDONOFFICIAL



X

@TOPDONOFFICIAL



RoHS



FR

PAPIER



ArtiDiag800 BT 2

USER MANUAL



TOPDON

Contents

Welcome.....	3
About.....	3
Package List.....	3
Compatibility.....	3
Notice.....	3
General Information of OBDII (On- Board Diagnostics II).....	4
Diagnostic Trouble Codes(DTCs).....	4
Product Description.....	5
Preparation & Connection.....	6
Operation Introduction.....	11
Technical Specification.....	24
Warnings.....	25
Cautions.....	25
FAQ.....	26
Warranty.....	27

Welcome

Thank you for purchasing TOPDON's ArtiDiag800 BT 2. Please read through and understand this User Manual before operating this product.

About

The ArtiDiag800 BT 2 is designed with technicians in mind. This 6" tablet-style scanner boasts high quality features and an easy workflow to tackle the common and complex diagnostic issues for most modern vehicles.

Package List

- ArtiDiag800 BT 2
- Type-C to USB Cable
- User Manual
- Carry Case
- 3 in 1 Adapter
- Quick User Guide

Compatibility

TOPDON ArtiDiag800 BT 2 is compatible with the following protocols:

- KWP2000
- ISO9141
- J1850 VPW
- J1850 PWM
- CAN(Controller Area Network)
- CANFD
- And more

Notice

The ArtiDiag800 BT 2 may automatically reset if it's disturbed by strong static electricity. **THIS IS A NORMAL REACTION.**

Read all instructions carefully and use the unit properly before operating. Failure to do so may cause damage and/or personal injury, which will void the product warranty.

General Information of OBDII (On- Board Diagnostics II)

The OBDII system is designed to monitor a vehicle's emission control systems and key engine components by performing either continuous or periodic tests of specific components and vehicle conditions. This is done with three pieces of such valuable information:

- Whether the Malfunction Indicator Light (MIL) is “on” or “off”;
- Which, if any, Diagnostic Trouble Codes (DTCs) are stored;
- Readiness Monitoring status.

Diagnostic Trouble Codes(DTCs)

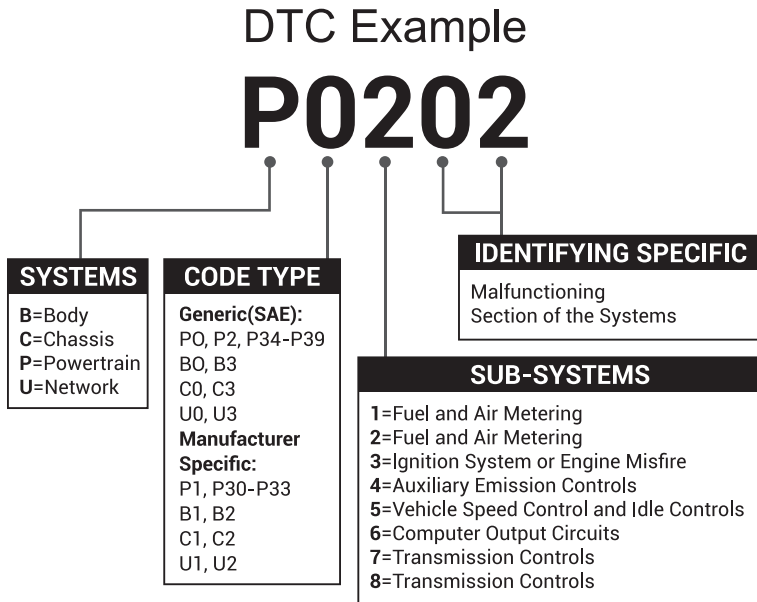

Product Description

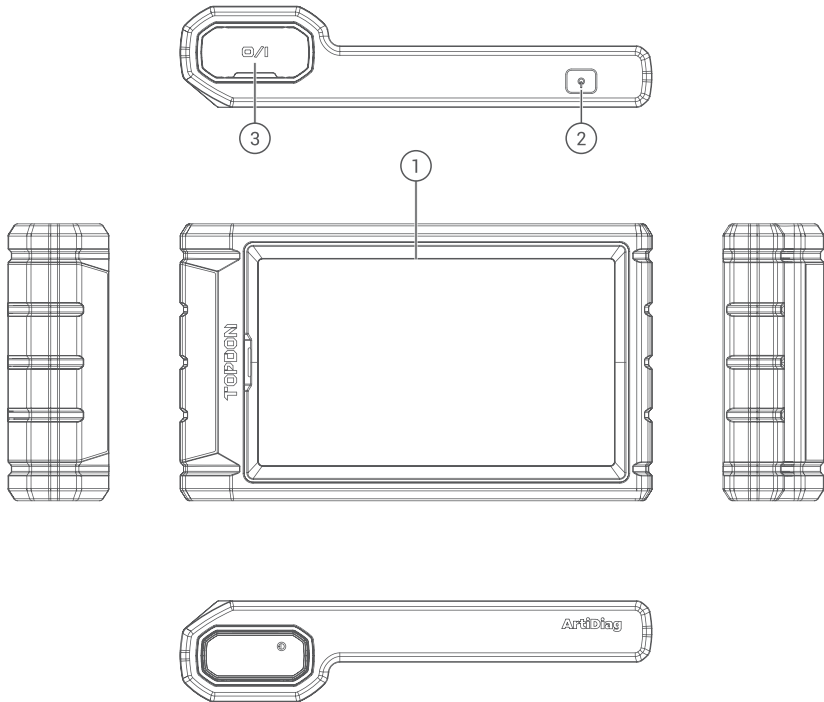

NO.	Name	Descriptions
1	Touch Screen	6 inches (1440*720).
2	On/Off key	Long press the button to turn the tablet on or off. Short press the button to wake up or lock the screen.
3	Charging Port	Type-C charging port & USB debugging port.

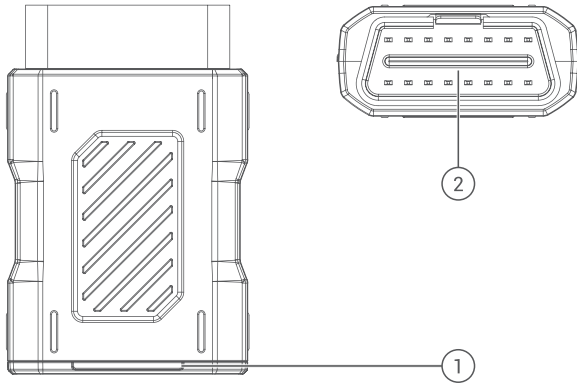

NO.	Name	Descriptions
1	Diagnostic MDCI Mini Dongle	Bluetooth diagnostic connector.
2	OBD Port	Plug into the DLC of the vehicle.

Preparation & Connection

1. Turn the ignition off.

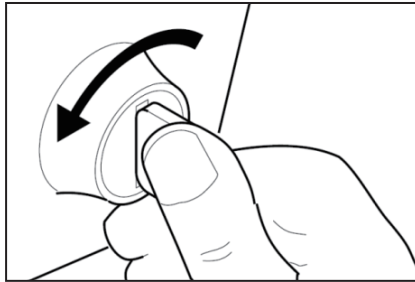

2. Locate the vehicle's DLC socket (OBDII Port).

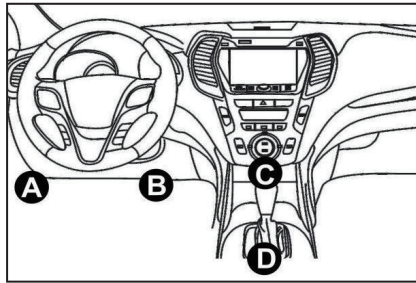

3. Plug the TOPDON ArtiDiag800 BT 2 Diagnostic MDCI Mini dongle into the vehicle's DLC socket.

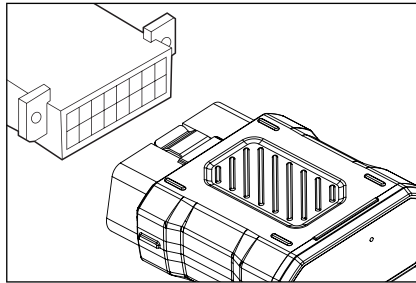

4. Turn the ignition on. The engine can be off or running.

5. Hold the On/Off Key for 3 seconds to turn the TOPDON ArtiDiag800 BT 2 on. The tablet will start initializing and enter the following interface.

TOPDON

* Note: Don't connect or disconnect any test equipment with the ignition on or engine running. Otherwise, device or vehicle data may be lost.

6. Language Setting

Used to select the tool language.

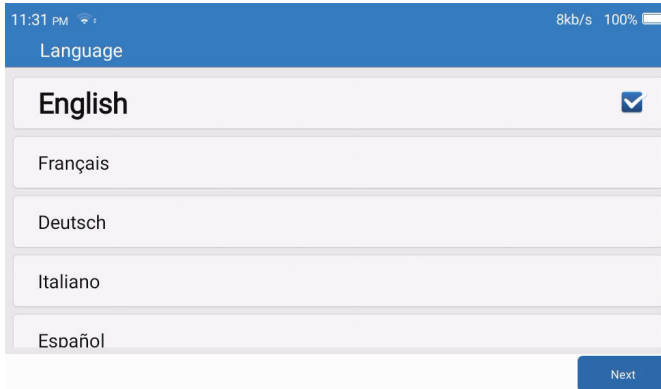

7. Connect Wi-Fi

The system will automatically search all available Wi-Fi networks. You can choose the Wi-Fi needed.

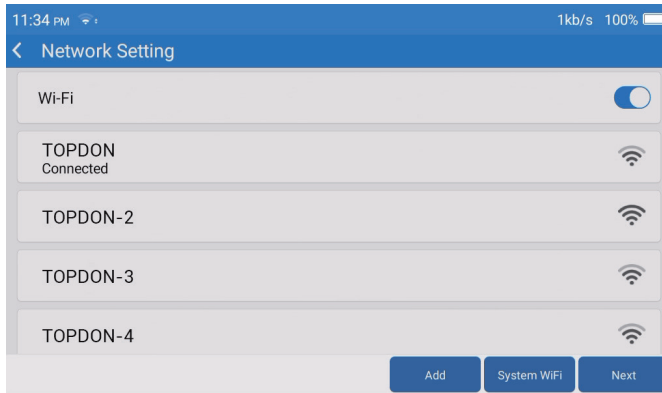

8. Select Time Zone

Choose the time zone of your current location. The system will automatically configure the time.



9. Registration Terms

Please read and agree to the registration terms, then tap "Next".

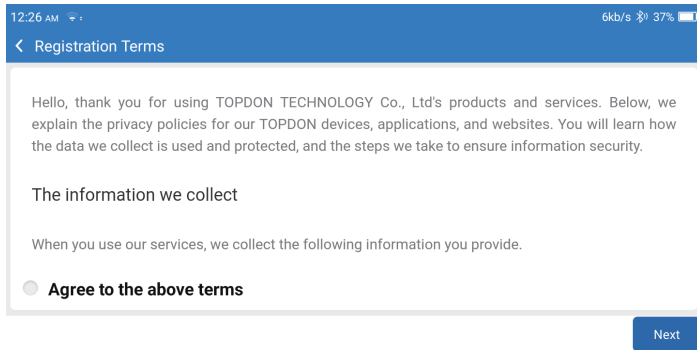

10. Login Account

Please enter your email, then obtain and enter the verification code and tap "Login".

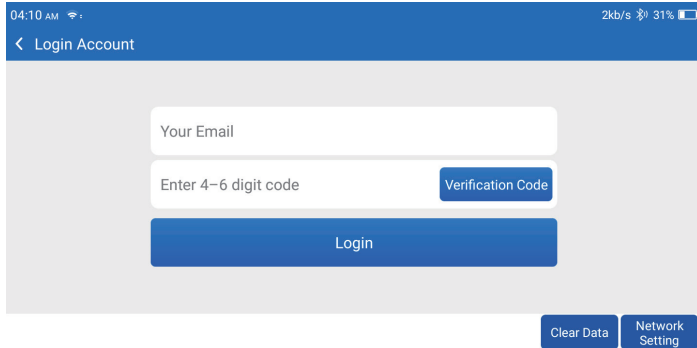

11. Quick Access

Swipe down the screen to open the shortcut entry of the function.

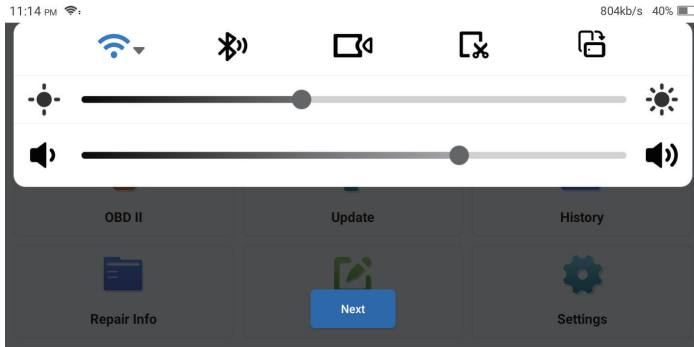

12. Operation Instructions

Swipe left or swipe right to return to the previous layer, tap "OK" to go to the home page.

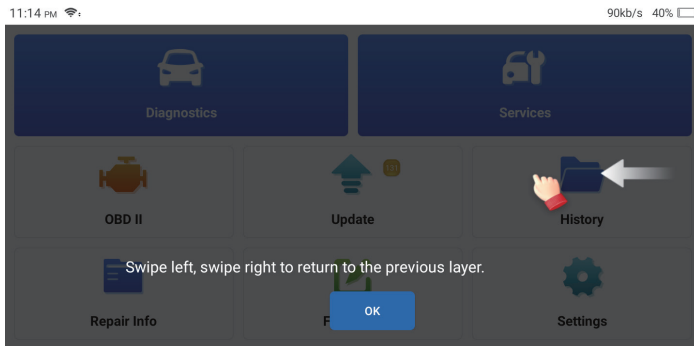

Operation Introduction

The TOPDON ArtiDiag800 BT 2 has 8 main modules: Diagnostics, Services, OBD II, Update, History, Repair Info, Feedback, and Settings.

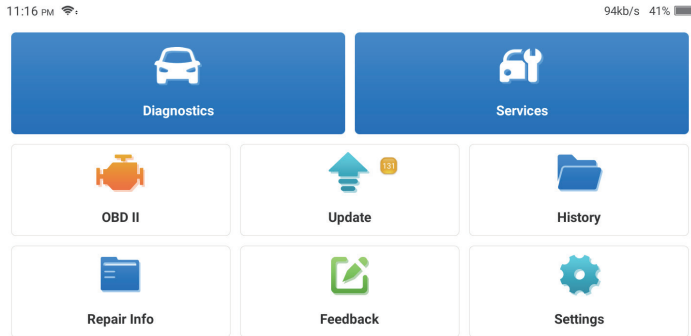

1. Diagnostics

This module has auto search (automatic scanning of car models' VIN), car model lists, a demo mode (demonstration of the diagnosis process), OBD & IM (10 emission-related module diagnosis).

1.1 Smart Diagnosis

Plug the dongle into the vehicle's DLC port, and tap "Diagnostics" in the main interface. Tap "AUTOSEARCH" to start communicating with the dongle via Bluetooth.

The system will automatically start scanning the vehicle's VIN after establishing stable communication.

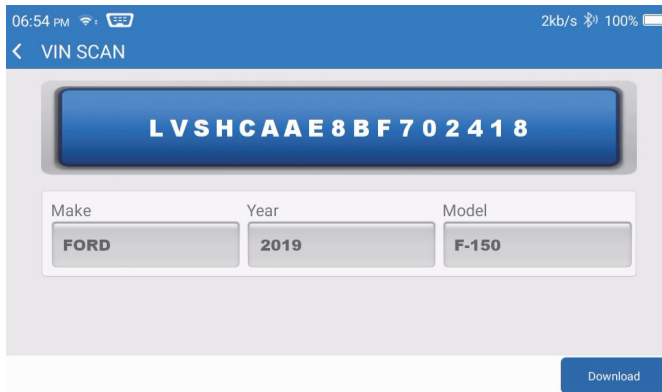

* Note: Follow the prompts to proceed if the communication failure occurs.

1.2 Manual Diagnosis

You need to enter the vehicle's VIN data manually if the ArtiDiag800 BT 2 fails to get access to the vehicle VIN data automatically.

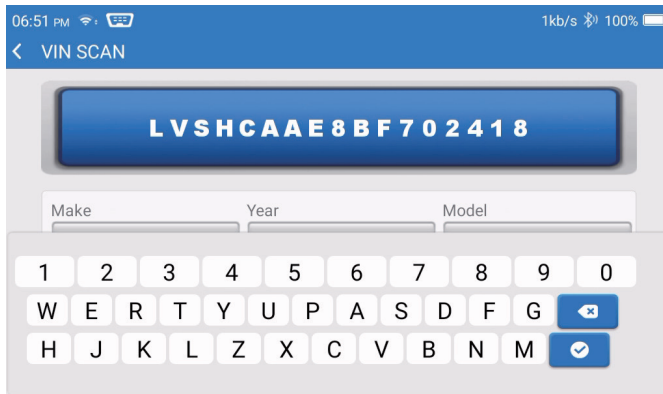

After reading VIN, the following screen may appear.

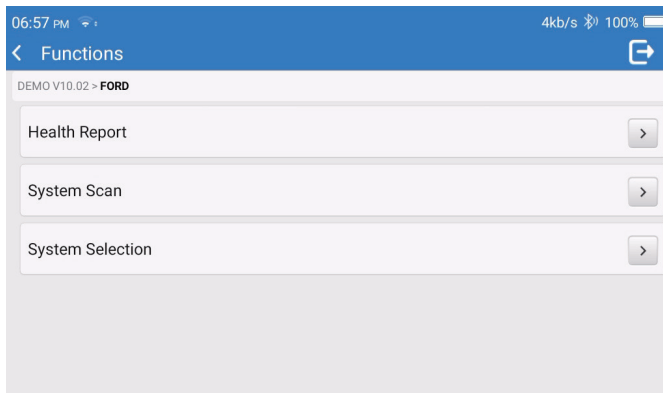

1.3 Health Report

This function can quickly reveal the vehicle's health status. Tap "Health Report". The system will start scanning DTCs and show the test results.

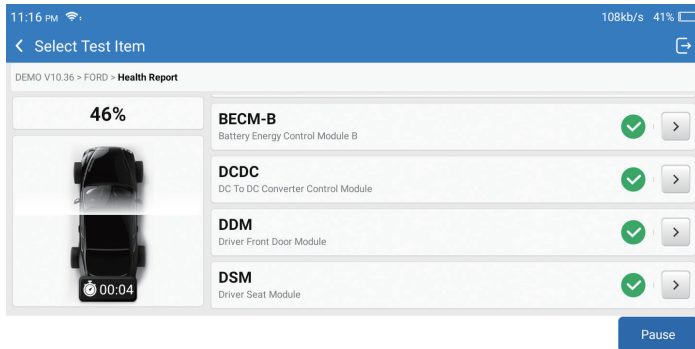

The DTC will be displayed on the screen in red font, with a specific definition.

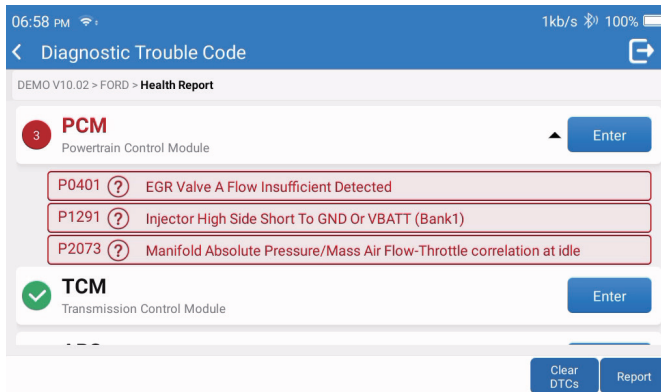

* Note: Follow the prompts to proceed if the communication failure occurs.

1.4 System Scan

This function will automatically scan all systems of the vehicle.

1.5 System Selection

This function allows you to manually choose the automotive electronic control system. Tap "PCM" (e.g.). The screen will show the selection interface.

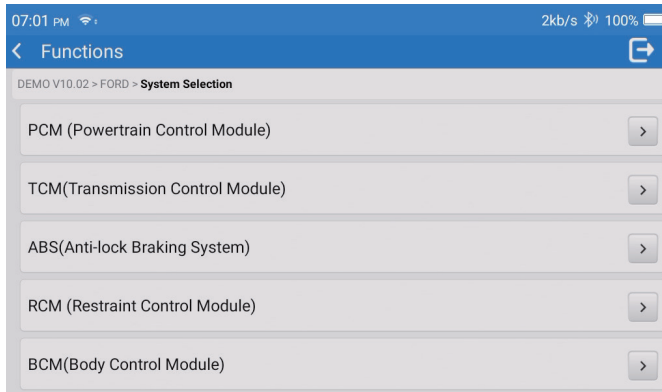

Choose the system to be tested. The following screen may vary by vehicle's make, model, and year.

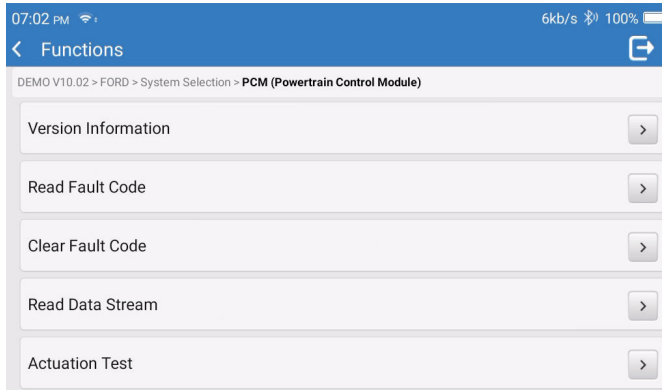

1.5.1 Version Information

This function reads the current version information of ECU.

1.5.2 Read Fault Code

This function can read the Diagnostic Trouble Codes (DTCs) in the ECU memory, helping quickly identify the cause of the vehicle breakdown.

Tap "Read Fault Code". The screen will display diagnostic results.

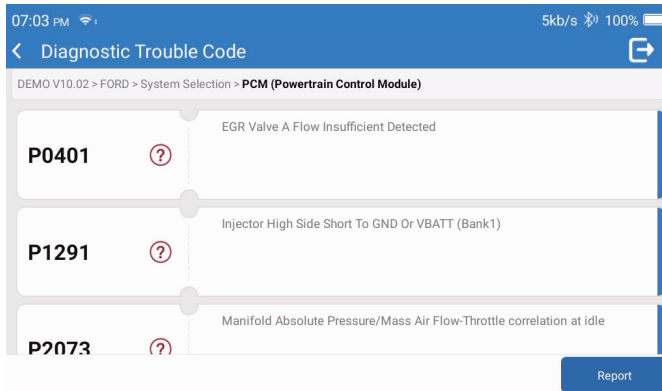

* Explanation of terms:

- Freeze Frame: Records specific data streams for verification when the car breaks down.
- Report: Saves the current diagnosis result as a diagnosis report, which can be sent to a specific E-Mail address.

1.5.3 Clear Fault Code

This function can clear the DTC of the ECU memory of the tested system.

1.5.4 Read Data Stream

This function can read and display the real-time data and parameters of the ECU. To view the specific data stream, check the box next to its name, and then tap "OK".

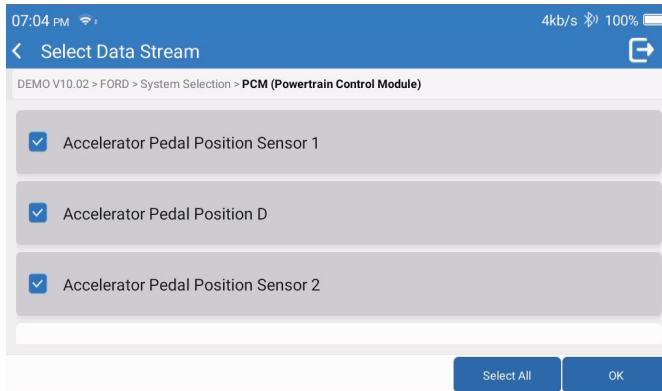

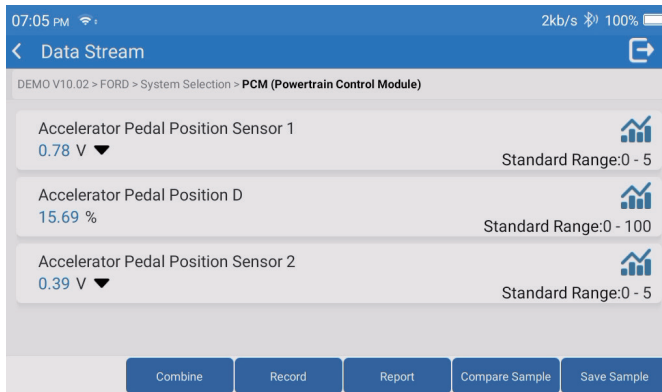

The system will display a maximum of four dynamic data streams in three modes:

- 1) Value (default): Shows parameters with numbers and lists.
- 2) Graph: Displays parameters with wave patterns.
- 3) Combine: The graphs can be merged for easier comparisons.



* Explanation of terms:

-  : To have the data streams displayed in wave patterns.
- Record: To record the diagnostic data for further analysis.
- Report: To save the current data stream report.

- Compare Sample: Contrast data flow functions.
 - Save Sample: Record the sample data stream.
- Tap  to have the data streams displayed in wave patterns.

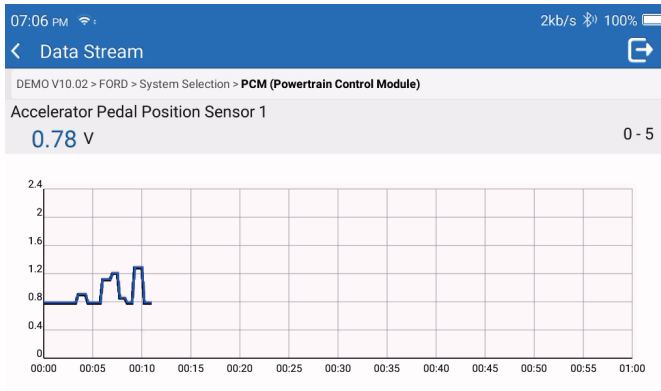

Tap "Combine". The system will display the merged parameters of the selected data streams with wave patterns.

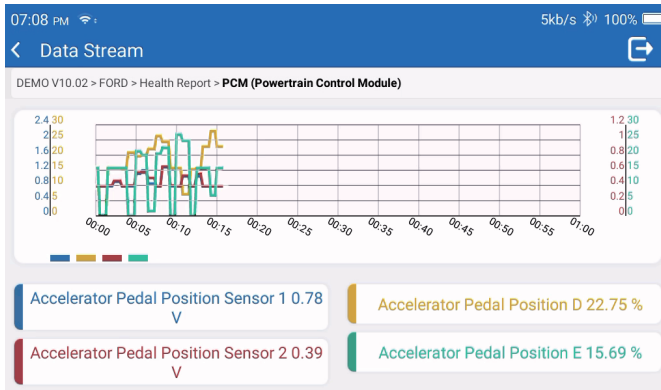

2. Services

Supports the most common multiple maintenance and reset functions, it involves in 28 reset functions, there

are shown as follows:

A/F tuning (AIRFUEL); ABS Bleeding (BLEED); Headlight Matching (AFS); Adblue Reset (ADBLUE); Suspension matching (SUS); Airbag reset (AIRBAG); Battery matching (BMS); Brake pad reset (BRAKE); Coolant Bleeding (COOLANT); DPF regeneration (DPF); EGR Reset (EGR); Throttle Matching (ETS); Gear Learning (GEAR); Gearbox Reset (BOX); Anti-theft matching (IMMO); Injector coding (INJEC); Language settings (LANGUAGE); NOx Sensor Reset (NOXSENSOR); ODO Meter Reset (ODO); Oil Reset (OIL); Seat calibration (SEAT); Steering angle reset (SAS); Start-stop setting (STOPSTART); Sunroof Initialization (SUN); Tire Pressure Reset (TPMS); Lifting mode of transport (TRANSPORT); Tire Reset (TYRE); Windows Calibration (WINDOW).

3. OBD II

This function presents a quick way to check for DTCS, isolate the cause of the illuminated Malfunction Indicator Lamp (MIL), check monitor status prior to emissions certification testing, verify repairs, and perform other services that are emission-related.

Tap "OBD II" in the Home Menu after the tablet is properly connected to the vehicle's DLC port. The tablet will start an automatic check of the vehicle's computer to determine which type of communication protocol it is using, then display the Monitor Status as follows:

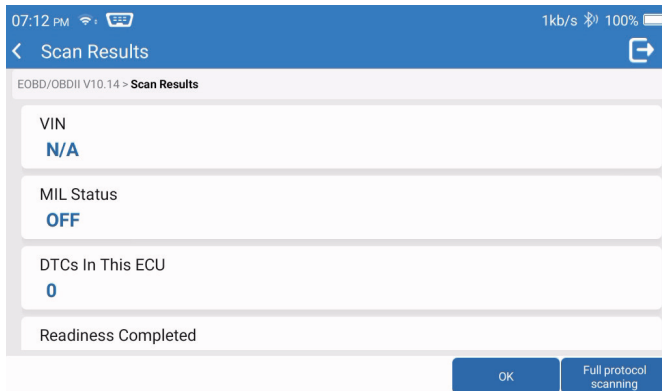

Tap "OK", the following OBDII function list appears.

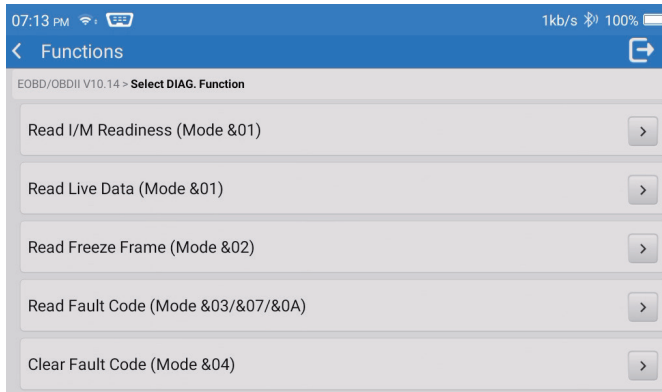

3.1 Read Fault Code

This function can identify which section of the emission control system has malfunctioned.

3.2 Clear Fault Code

This function erases the codes from the vehicle, after retrieving codes from the vehicle and certain repairs have been carried out.

Make sure the vehicle's ignition key is in the ON position with the engine being off before the operation.

3.3 Read I/M Readiness

This function checks whether or not the various emissions-related systems on the vehicle are operating properly, and are ready for Inspection and Maintenance testing.

It can also be used to check the Monitor Run Status and to confirm if the repair of a car fault has been performed correctly.

3.4 Read Live Data

This function retrieves and displays live data and parameters from the vehicle's ECU.

3.5 Read Freeze Frame

This function takes a snapshot of the operating conditions when an emission-related fault occurs.

3.6 Test Results: O2 Sensor Monitor

This function retrieves O2 sensor monitor test results of the most recently completed tests from the vehicle's on-board computer.

3.7 Test Results: On-Board Monitoring Test

This function retrieves test results for emission-related powertrain components and systems that are not continuously monitored. The test's availability is determined by the vehicle manufacturer.

3.8 Control Operation of On-Board Component/System

This function initiates a leak test for the vehicle's EVAP system.

Refer to the vehicle's service repair manual to determine the procedures necessary to stop the test.

3.9 Read Vehicle Information

This function retrieves a list of information (provided by the vehicle manufacturer) from the vehicle's on-board computer.

This information may include:

- VIN(Vehicle Identification Number).
- CID(Calibration ID).
- CVN (Calibration Verification Number).

4. Update

This module allows you to update the diagnostic software & App to the latest version.

A pop-up message will indicate new software is available if you don't update the software in the process of registration.

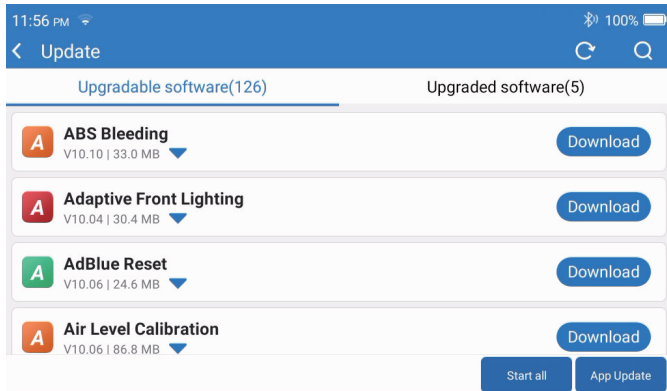

5. History

The tablet will record the details of every diagnostic session.

The History function provides direct access to the previously tested vehicles. Users can resume from the last operation, without the necessity of starting from scratch.

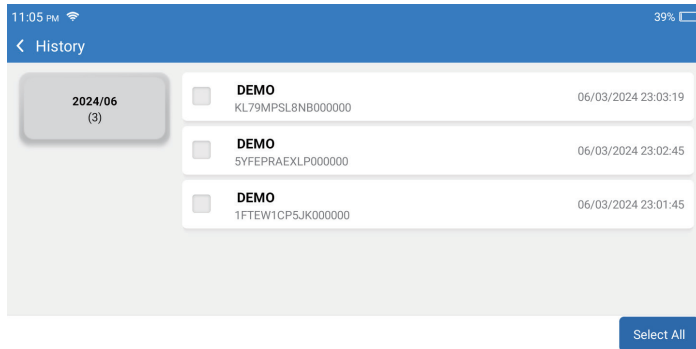

6. Repair Info

This module includes four sections:

- 1) OBD Fault Code Library: The detailed explanation of the fault codes.
- 2) Coverage List: The supported vehicles' information.
- 3) Video: Contains table usage tips, maintenance, and diagnostic guides.

4) Learning: Demonstrates how to operate the tool.

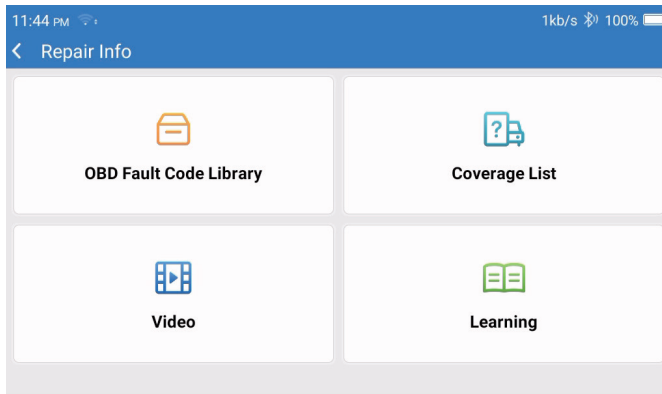

7. Feedback

You can feedback the diagnostic software/app bugs to us for analysis and improvements.

8. Settings

You can do some basic set up in this page. Include Wi-Fi, screen brightness, language, time zone and so on.

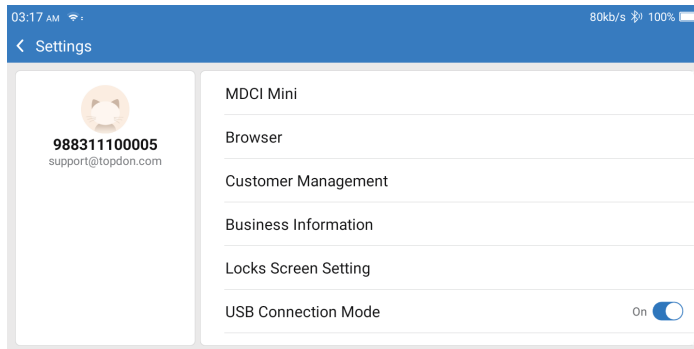

1) MDCI Mini: Check or replace the MDCI Mini.

2) Browser : Built-in Google Chrome.

- 3) Customer Management : Record user information.
- 4) Locks Screen Setting: Set the unlock screen method to swipe, pattern, PIN or password.
- 5) Business Information : Set the basic information of the merchant and display it in the report.
- 6) USB Connection Mode : Set the connection mode of the USB interface.
- 7) Silent Upgrade Software : System background automatic upgrade switch.
- 8) Screen Shots : Use this switch to take a screen capture.
- 9) Photo Album : Screenshot storage.
- 10) Screen Floating Window : Turn on this switch to record the screen operation video.
- 11) Screen Recorder : Screen recording video storage.
- 12) Wi-Fi : Set the connectable Wi-Fi network.
- 13) Brightness : Set screen brightness.
- 14) Language : Select the tool language.
- 15) Unit Of Measure : Metric/imperial.
- 16) Time Zone : Choose the time zone of the current location, then the system will automatically configure the time according to the time zone you chose.
- 17) Sleep Time : Set sleep time to save battery power.
- 18) Firmware Fix : Used to update the firmware.
- 19) Clear Data : Clear user data.
- 20) File Manager : System file manager.
- 21) Cast Screen : Please connect the product and computer to the same router, then turn on the screen projection function on the computer and select the computer to be projected on this product.
- 22) Help : Equipment FAQ.
- 23) Remote Assistance: Remote assistance function, applicable to regions where Remote Support is not available.
- 24) Remote Support: Remote support function.
- 25) APP Update : Update application.
- 26) About : Basic information about this device.

Technical Specification

TOPDON ArtiDiag800 BT 2 Tablet

- Battery Capacity : 6300 mAh/3.8V
- Screen Size : 6 inches
- Resolution : 1440*720 Pixels
- Working Voltage : 5V

- Working Current : $\leq 2.5A$
- Working Environment : $32^{\circ}F \sim 122^{\circ}F$ ($0^{\circ}C \sim 50^{\circ}C$)
- Storage Environment : $-4^{\circ}F \sim 140^{\circ}F$ ($-20^{\circ}C \sim 60^{\circ}C$)

TOPDON ArtiDiag800 BT 2 Diagnostic MDCI Mini Dongle

- Working Voltage : 9-18V
- Working Current : $\leq 130mA$
- Working Environment : $14^{\circ}F \sim 122^{\circ}F$ ($-10^{\circ}C \sim 50^{\circ}C$)
- Storage Environment : $-4^{\circ}F \sim 144^{\circ}F$ ($-20^{\circ}C \sim 60^{\circ}C$)

Warnings

- ✔ Always perform automotive testing in a safe environment.
- ✔ DO NOT smoke near the vehicle during testing.
- ✔ DO NOT place the code reader near the engine or exhaust pipe to avoid damage from high temperatures.
- ✔ DO NOT wear loose clothing or jewelry when working on an engine.
- ✔ DO NOT connect or disconnect any test equipment while the ignition is on or the engine is running.
- ✔ DO NOT disassemble the code reader.
- ✔ Engine parts will become hot when the engine is running. To prevent severe burns avoid contact with hot engine parts.
- ✔ When an engine is running, it produces carbon monoxide, a toxic gas. Operate the vehicle ONLY in a well-ventilated area.
- ✔ Wear eye protection that meets ANSI standards.

Cautions

- ✔ Please ensure that the vehicle battery is fully charged, and the scanner is firmly connected to the vehicle DLC to avoid erroneous data generated by the scanner and diagnostic systems.
- ✔ Please do not use the diagnostic tool during driving.

- ✔ Keep clothing, hair, hands, tools, test equipment, etc. away from all moving or hot engine parts.
- ✔ Keep the scanner dry, clean, free from oil/water, or grease. Use a mild detergent on a clean cloth to clean the outside of the scan tool, when necessary.
- ✔ Keep the scanner out of the reach of children.

FAQ

Q: Why does the ArtiDiag800 BT 2 have no responses when it is connected to a car?

A: Please confirm the following cases:

- Whether the connection with the vehicle diagnostic socket is solid.
- Whether the ignition switch is on.
- Whether the tool supports the car.
- Whether the version of the scanner and MDCI Mini is the latest (if not, try again after updating).
- Check what indicator is on the MDCI Mini (refer to the indicator description in the user manual).

Q: Why does the system stop when reading the data stream?

A: This may be caused by the loose diagnostic MDCI Mini dongle.

Please unplug the MDCI Mini dongle, and make sure the reconnection is stable and solid.

Q: Communication error with vehicle ECU?

A: Please confirm the following cases:

- Whether diagnostic MDCI Mini dongle is correctly connected.
- Whether the version of the scanner and MDCI Mini is the latest (if not, try again after updating).
- Check what indicator is on the MDCI Mini (refer to the indicator description in the user manual).
Or, send your vehicle's year, make, model and VIN number to us using Feedback feature for timely technical assistance.

Q: Why does the screen flash when the engine ignition starts?

A: It is normal and caused by electromagnetic interference.

Q: How to upgrade the system software?

A: 1. Power on the tool and ensure a stable Internet connection.

2. Go to "Settings"-> "App Update", tap "OTA" and then tap "Check Version" to enter the system upgrade interface.

3. Complete the process by following the instructions on the screen step by step. It may take a few minutes depending on the status of your network.

After the upgrade is finished, the tool will automatically restart and display the main interface.

Q: How to capture the screenshot?

A: Tap the "" icon on the screen to capture the current screen, which will be saved in the "Photo Album" module.

Q: Does the MDCI Mini dongle need to be updated?

A: Yes, go to [Settings] on the home screen and find [Firmware Fix] to update. You can only update the firmware when the scanner is connected to the internet, and the MDCI Mini is connected to a vehicle. After the firmware update is complete, remove and re-plug the MDCI Mini on the firmware update completion page.

Warranty

TOPDON's One Year Limited Warranty

TOPDON warrants to its original purchaser that the company's products will be free from defects in material and workmanship for 12 months from the date of purchase (Warranty Period).

For the defects reported during the Warranty Period, TOPDON will either repair or replace the defective part or product according to its technical support analysis and confirmation.

TOPDON shall not be liable for any incidental or consequential damages arising from the device's use, misuse, or mounting.

If there is any conflict between the TOPDON warranty policy and local laws, the local laws shall prevail.

This limited warranty is void under the following conditions:

- Misused, disassembled, altered or repaired by unauthorized stores or technicians.
- Careless handling and/or improper operation.

Notice: All information in this manual is based on the latest information available at the time of publication and no warranty can be made for its accuracy or completeness. TOPDON reserves the right to make changes at any time without notice.

FCC Statement:

Any changes or modifications not expressly approved by the party responsible for compliance could void the user's authority to operate the equipment. This device complies with Part 15 of the FCC Rules. Operation is subject to the following two conditions:

- (1) this device may not cause harmful interference, and
 - (2) this device must accept any interference received, including interference that may cause undesired operation.
- Note: This equipment has been tested and found to comply with the limits for a Class B digital device, pursuant to Part 15 of the FCC Rules. These limits are designed to provide reasonable protection against harmful interference in a residential installation. This equipment generates, uses, and can radiate radio frequency energy, and if not installed and used in accordance with the instructions, may cause harmful interference to radio communications. However, there is no guarantee that interference will not occur in a particular installation. If this equipment does cause harmful interference to radio or television reception, which can be determined by turning the equipment off and on, the user is encouraged to try to correct the interference by one or more of the following measures:
- Reorient or relocate the receiving antenna.
 - Increase the separation between the equipment and receiver.
 - Connect the equipment into an outlet on a circuit different from that to which the receiver is connected.
 - Consult the dealer or an experienced radio/TV technician for help.

IC Warning

This device complies with Industry Canada's license-exempt RSSs. Operation is subject to the following two conditions: (1) This device may not cause interference; and (2) This device must accept any interference, including interference that may cause undesired operation of the device.

Le présent appareil est conforme aux CNR d'Industrie Canada applicables aux appareils radio exempts de licence. L'exploitation est autorisée aux deux conditions suivantes : (1) l'appareil ne doit pas produire de brouillage, et (2) l'utilisateur de l'appareil doit accepter tout brouillage radioélectrique subi, même si le brouillage est susceptible d'en compromettre le fonctionnement.

The device has been evaluated to meet general RF exposure requirement. The device can be used in portable exposure condition without restriction.

L'appareil a été évalué pour répondre aux exigences générales en matière d'exposition aux RF. L'appareil peut être utilisé en condition d'exposition portable sans restriction.